



Friedhelm TRAPP GmbH

Ostring 15 - 63533 Mainhausen - Zentrale: 06182/9294-5 - Fax: 06182/9294-69 - Mail: trapp@f-trapp.de

www.f-trapp.de

Geländer TGB-2005



Produktbeispiel TGB-2005



Friedhelm TRAPP GmbH

Ostring 15 - 63533 Mainhausen - Zentrale: 06182/9294-5 - Fax: 06182/9294-69 - Mail: trapp@f-trapp.de

www.f-trapp.de

Geländer TGB-2005

Bemaßung

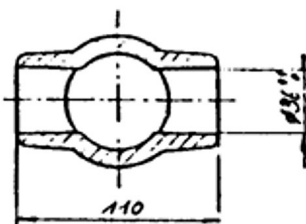
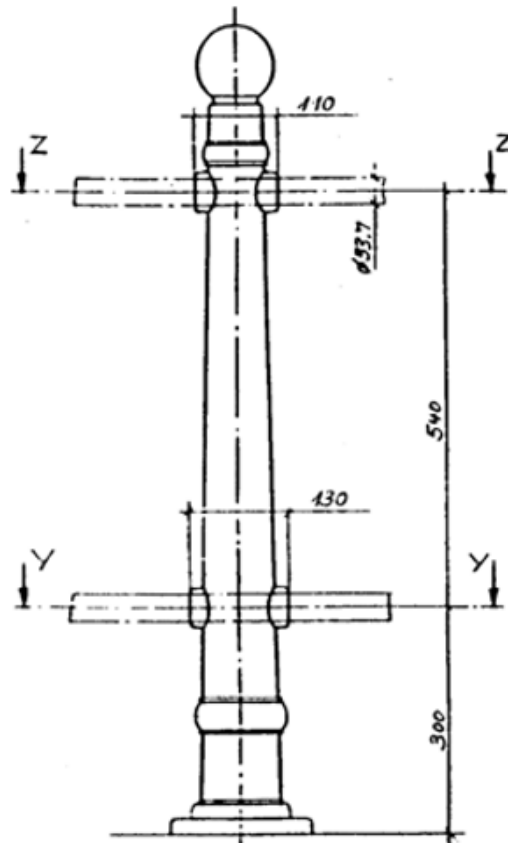

Mittelposten Nr. 2005-4 A Schnitt Z-Z

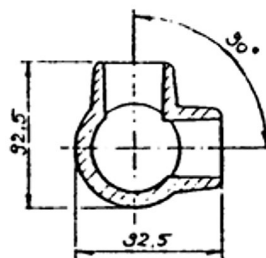

Eckposten Nr. 2005-4 B Schnitt Z-Z

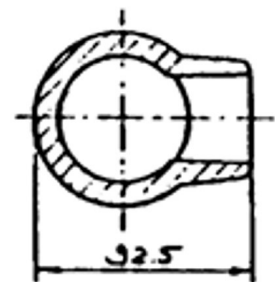

Endposten Nr. 2005-4 C Schnitt Z-Z

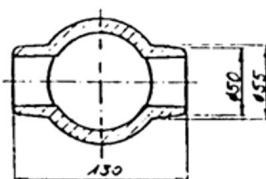

Mittelposten Nr. 2005-4 A Schnitt Y-Y

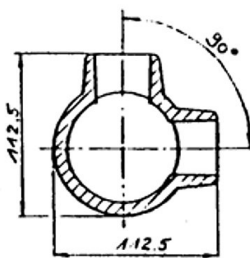

Schnitt Y-Y

Eckposten Nr. 2005-4 B Schnitt Y-Y

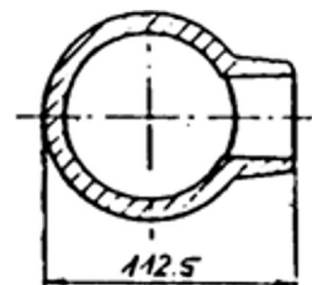

Endposten Nr. 2005-4 C Schnitt Y-Y



Friedhelm TRAPP GmbH

Ostring 15 - 63533 Mainhausen - Zentrale: 06182/9294-5 - Fax: 06182/9294-69 - Mail: trapp@f-trapp.de

www.f-trapp.de

Geländer TGB-2404



Poller Nr. 2404 zur Abgrenzung von Grünflächen

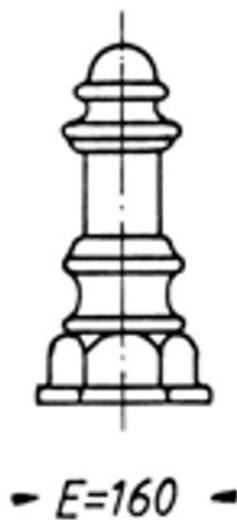

Poller Nr. 2404-1 zum Aufflanschen

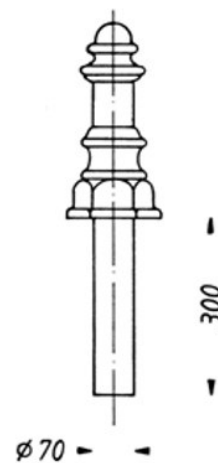

Poller Nr. 2404-2 zum Einbetonieren



Friedhelm TRAPP GmbH

Ostring 15 - 63533 Mainhausen - Zentrale: 06182/9294-5 - Fax: 06182/9294-69 - Mail: trapp@f-trapp.de

www.f-trapp.de

Verbindungsrohr 5001



Verbindungsrohr Nr. 5001

Zur Abgrenzung von Grünflächen in Verbindung mit Poller Nr. 2404
Als Geländer in Verbindung mit Poller Nr. 2004 oder Nr. 3002
Auch in den Längen von 1 m und 2 m lieferbar

Material:
Stahlrohr, feuerverzinkt, Zierteile und Bodenhülse
aus Aluminiumguss

Lackierung:
2-fach, Endlack nach Wunsch

Befestigungselemente für Nr. 5001:
VA-Gewindestifte

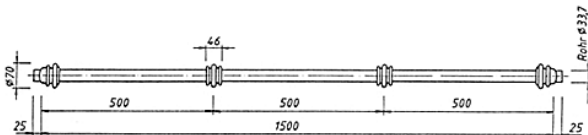



Friedhelm TRAPP GmbH

Ostring 15 - 63533 Mainhausen - Zentrale: 06182/9294-5 - Fax: 06182/9294-69 - Mail: trapp@f-trapp.de

www.f-trapp.de

Geländer zur Grünflächenbegrenzung

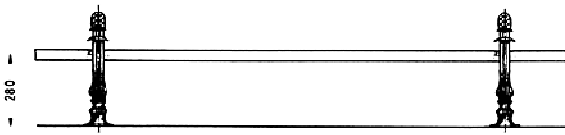

Grünflächenbegrenzung TGB-2101

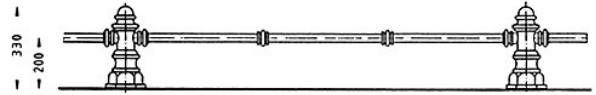

Grünflächenbegrenzung TGB-2404

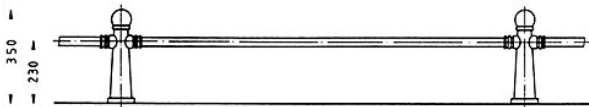

Grünflächenbegrenzung TGB-2505



Grünflächenbegrenzung TGB-3505



Friedhelm TRAPP GmbH

Ostring 15 - 63533 Mainhausen - Zentrale: 06182/9294-5 - Fax: 06182/9294-69 - Mail: trapp@f-trapp.de

www.f-trapp.de

Geländer zur Grünflächenbegrenzung

Beispiele



TGB-2102

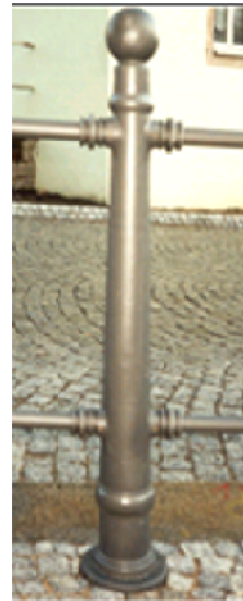

TGB-2005



TGB-3005



TGB-3006